

M12 male 0° /Push Pull RJ45 0° shielded

PUR 1x4xAWG22 shielded gn UL/CSA+robot 5m

Ethernet CAT5

Plastic housings with good resistance against chemicals and oils.

Male straight – male straight

M12 – RJ45PP, 4-pole

D-coded

shielded

8-pole partly used

Push Pull

Transmission properties with channel transmission up to 100 m

Further cable lengths on request.

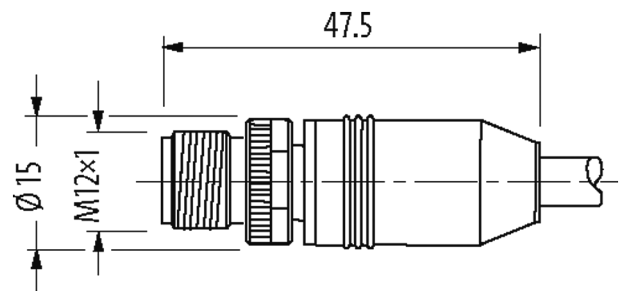
Illustration

Product may differ from Image

Approvals

* only for products with UL/CSA approved cable

More Info

EtherNet/IP



Form

Form 44715

CablesNo./diameter of wires 1 x 4 x 0.34 mm²

Wire isolation PE (wh, ye, bl, or)

Material (jacket) PUR (UL/CSA)

Outer Ø 6.6 mm ±5%

Bend radius (moving) 12x outer Ø

Temperature range (fixed) -40...+80 °C

Temperature range (mobile)	-20...+60 °C
Cable identification	793
Approval (cable)	UL (AWM-Style 20233/10578), CSA; CE
Cable weight [g/m]	69,30
Material (wire)	Cu wire, tin plated
Resistor (core)	max. 60 Ω/km (20 °C)
Single wire Ø (core)	0.16 mm
Construction (core)	19× 0.160 mm
Diameter (core)	1 × 4× AWG22/19 (0.382)
Material (wire isolation)	PE
Wire-Ø incl. isolation	1.6 mm ±5%
Color/numbering of wires	wh, ye, bl, or
Shield	yes
	min. 85%
Material (jacket)	PUR
Outer-Ø (jacket)	6.6 mm ±5%
Color (jacket)	green
chemical resistance	good resistance to oil, gasoline and chemicals
thermal resistance	flame retardant
Nominal voltage	300 V
Temperature range (fixed)	-40...+80 °C
Temperature range (mobile)	-20...+60 °C
Bend radius (fixed)	8× outer Ø
Bend radius (moving)	12× outer Ø
Torsion stress	±180°/m
No. of torsion cycles	max. 4 Mio. (25 °C)
Jacket Color	green

Technical Data

Operating voltage	max. 60 V DC
Operating voltage (only UL listed)	max. 30 V DC
Rated surge voltage	1.5 kV
Operating current per contact	max. 1.76 A
Material group	IEC 60664-1, category I
Transfer parameters	CAT5, Class D (ISO/IEC 11801:2002), (EN 50173-1)
Transfer rate	up to 100 Mbit/s full duplex
Coding	M12, D-coded
Locking of ports	Screw thread (M12×1 mm) recommended torque 0.6 Nm, self-securing
Compression gland	M12 (SW13)
Protection	IP65 and IP67 when plugged and screwed down (EN 60529)
Locking material	Zinc die casting, matte nickel plated
Material	PUR
suitable for corrugated tube (internal Ø)	without

General data

Standards	DIN EN 61076-2-101 (M12)
Pollution Degree	3
Temperature range	-25...+85 °C, depending on cable quality

Commercial data

country of origin	DE
-------------------	----

customs tariff number	85444210
EAN	4048879566353
eClass	27061801
Packaging unit	1

Sketch

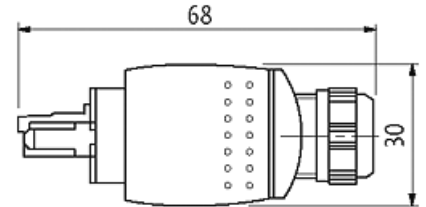

Height: 22 mm

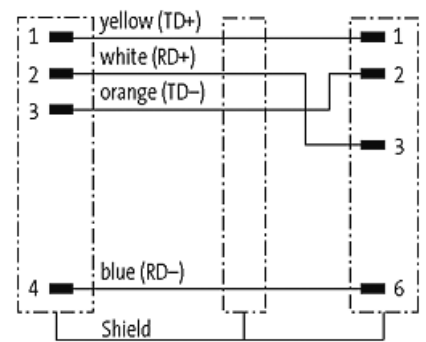

Male

Male



Product may differ from Image